

This article was downloaded by:

On: 16 January 2011

Access details: *Access Details: Free Access*

Publisher *Taylor & Francis*

Informa Ltd Registered in England and Wales Registered Number: 1072954 Registered office: Mortimer House, 37-41 Mortimer Street, London W1T 3JH, UK



Journal of Energetic Materials

Publication details, including instructions for authors and subscription information:

<http://www.informaworld.com/smpp/title~content=t713770432>

Explosive Detection by Microthermal Analysis

Asaf Zuck^a; Jeremy Greenblatt^a; Adi Zifman^a; Amalia Zaltsman^a; Shay Kendler^a; Gad Frishman^a; Sheffer Meltzer; Ilanit Fisher

^a Israel Institute for Biological Research, Ness Zionna, Israel

To cite this Article Zuck, Asaf , Greenblatt, Jeremy , Zifman, Adi , Zaltsman, Amalia , Kendler, Shay , Frishman, Gad , Meltzer, Sheffer and Fisher, Ilanit(2008) 'Explosive Detection by Microthermal Analysis', *Journal of Energetic Materials*, 26: 3, 163 – 180

To link to this Article: DOI: 10.1080/07370650801922286

URL: <http://dx.doi.org/10.1080/07370650801922286>

PLEASE SCROLL DOWN FOR ARTICLE

Full terms and conditions of use: <http://www.informaworld.com/terms-and-conditions-of-access.pdf>

This article may be used for research, teaching and private study purposes. Any substantial or systematic reproduction, re-distribution, re-selling, loan or sub-licensing, systematic supply or distribution in any form to anyone is expressly forbidden.

The publisher does not give any warranty express or implied or make any representation that the contents will be complete or accurate or up to date. The accuracy of any instructions, formulae and drug doses should be independently verified with primary sources. The publisher shall not be liable for any loss, actions, claims, proceedings, demand or costs or damages whatsoever or howsoever caused arising directly or indirectly in connection with or arising out of the use of this material.

Explosive Detection by Microthermal Analysis

ASAF ZUCK,¹ JEREMY GREENBLATT,¹
ADI ZIFMAN,¹ AMALIA ZALTSMAN,¹
SHAY KENDLER,¹ GAD FRISHMAN,¹
SHEFFER MELTZER,² and ILANIT
FISHER²

¹Israel Institute for Biological Research,
Ness Zionna, Israel

²Rafael, Haifa, Israel

Differential scanning microcalorimetry at high heating rates of $\sim 300^\circ\text{C}/\text{s}$ was performed on 30- to 100- μm -size explosive particles using two MEMS-based thermal conductivity gauges in air and under N_2 . The gauges consist of a thin-film Si_3N_x membrane with a centrally located Al thin-film heater, which is surrounded by six thin-film Si/Al junctions, creating a temperature-sensitive thermopile ($\sim 1.3\text{ mV}/\text{K}$) with an effective sensitive area of ca. $200 \times 200\ \mu\text{m}$. Heating was carried out by applying a linear voltage ramp during 1.6 s. The measurements were performed in a specially designed exposure chamber having a transparent glass lid that enabled optical observation of the thermal process.

Besides explosives (TNT, RDX, picric acid, urea nitrate, and TATP) we have studied nonexplosive materials, organic and inorganic, in order to see whether the explosives have a unique response. The materials we studied were oxygen-poor and -rich organic compounds (polyethylene and sugars, respectively), sea sand, and iron flakes.

Address correspondence to Asaf Zuck, Israel Institute for Biological Research, P. O. Box 19, Ness Zionna 4100, Israel. E-mail: zuck@iibr.gov.il

Clear, well-resolved exotherms were obtained at moderated temperatures ($\sim 250^{\circ}\text{C}$) for all types of explosive materials tested by us. In addition, all explosives exhibited a melting endotherm preceding the exotherm. Sea sand and iron showed no peaks at the heating temperature range. Polyethylene showed an endotherm representing its melting. The sugars showed an endotherm but also an exotherm when heated to elevated temperatures ($> 370^{\circ}\text{C}$). The thermogram of each material depends on its properties and is characterized by a unique pattern. This pattern may enable the detection and identification of explosive particles using this technology.

Keywords: explosive detection, MEMS, micro-calorimeter, thermal analysis

Introduction

An important technological challenge for homeland security is the detection of concealed explosive charges. For this purpose, controlling and monitoring actions are performed at checkpoints located in airports, harbors, border crossings, and terminals, using “sniffers” of various kinds. The sniffers may utilize the following technologies: ion mobility spectrometry (IMS), chemiluminescence (CL), electron capture detector (ECD), surface acoustic waves (SAW) [1,2] and quartz crystal microbalance (QCM) [3]. All of these technologies track specific chemical properties of the various explosives.

We suggest an alternative approach for explosive detection in which we use a property that is common to all types of explosives and distinguishes them from nonexplosive materials. This differentiation is based upon the thermal analysis profile of the suspected material. Chen et al. had stated that “Explosives are high energy, low stability compounds which exothermally decompose with heat in the absence of air. In contrast, stable compounds decompose endothermally” [4]. It was also claimed in that paper that sugars, which are oxygen-rich organic compounds, will decompose endothermally upon heating in the absence of gaseous oxygen like all other stable compounds [4].

Recent developments in DSC (differential scanning calorimetry) and DTA (differential thermal analysis) allow considering DSC/DTA for rapid and highly sensitive detection of trace amounts of all energetic compounds. An example of such an apparatus is model 2990 μ TA Micro-Thermal Analyzer of TA Inst. Inc., Newcastle, Delaware, which Chen et al. [4,5] used for microthermal analysis of explosives (submicron-size grains). The analyzer is based on a Wollaston-wire probe, which acts simultaneously as heater and thermal sensor and is usually used for thermal conductivity scanning in atomic force microscopy. An important conclusion from their work is that all explosives, of any character or composition, can readily be detected by thermal analysis. Moreover, since thermal analysis has an inherent capability for detection of any and all explosives, no modification of the analyzer will be required for new explosives. However, the μ TA Micro-Thermal Analyzer used for the study is unsuitable for field applications being mechanically sensitive, complicated, and probably expensive. For this application, a simple, robust, and low-cost system is required.

Micro-electro-mechanical systems (MEMS) have ample advantages for the fabrication of a miniature calorimeter that might be used for the detection of explosive particles. MEMS technology allows manufacturing of ultra-lightweight heating elements and temperature sensors. By utilizing MEMS techniques, an integrated microcalorimeter comprising a low thermal mass might be designed and fabricated resulting in a fast and accurate calorimeter. This miniature device will allow measuring small temperature differences induced by heating tiny amount (theoretically, at the picogram range) of the tested sample, therefore providing the speed and sensitivity required for field analysis of trace amounts of explosives. An example for an ultra-lightweight heating elements fabricated utilizing MEMS techniques is a micro-hot plate (MHP) [6]. The MHPs are usually comprised from a heating resistor deposited on a 0.5- μ m-thick silicon nitride membrane. Due to its small mass, the heating and cooling rates can be very high (up to tens of thousands degrees per seconds). Recently, Adamovski et al. [7]

and Adamovski and Schick [8] had used a commercially available thermal conductivity gauge (TCG 3880 by Xensor Integration) as a thin-film microcalorimetric device for scanning microcalorimetry of polyethylene at high cooling rates.

Experimental

Thermal conductivity gauge was used as microcalorimeter for the thermal analysis. The thermal conductivity gauge is a sensor closely related to the traditional thermocouple gauge and the Pirani gauge. The sensor chip consists of a silicon rim of 2.50×3.33 mm, 0.3 mm thick, surrounding a silicon-nitride membrane. The membrane dimensions are 1.5×2 mm, $0.5 \mu\text{m}$ thick. Underneath the membrane there is a thicker silicon mesa that connects to the four corners of the silicon rim. An Al thin-film heater is located in the center of the membrane. The heater is surrounded by six serially connected thin-film Si/Al hot junctions, creating a temperature-sensitive thermopile around the center of the membrane with an effective sensitive area of about $200 \times 200 \mu\text{m}$. The cold junctions of the thermopile are located on the thick silicon rim. The thermopile sensitivity is approximately 1.3 mV/K [9]. Figure 1 shows a scheme of the thermal conductivity gauge.

The thermal conductivity gauge is normally used as a vacuum sensor. A constant voltage is applied to the heater, and the voltage generated by the thermopile, which is a direct measure of their temperature, is affected by heat conduction by air, which is pressure dependent. In our application we have ramped the voltage of the heater and monitored the temperature change of the loaded membrane.

Two thermal conductivity gauge sensors were mounted and wire-bonded to a Kyocera LCC-68 Leadless Chip Carrier (68 pins, 25×25 mm), of Kyocera, Inc., Japan. One TCG was used for sample measurement while the other served as a reference. From the thermopile voltage differences between the loaded and reference TCG one could derive the net heat flow at different temperatures. The microcalorimeter was housed in an aluminum

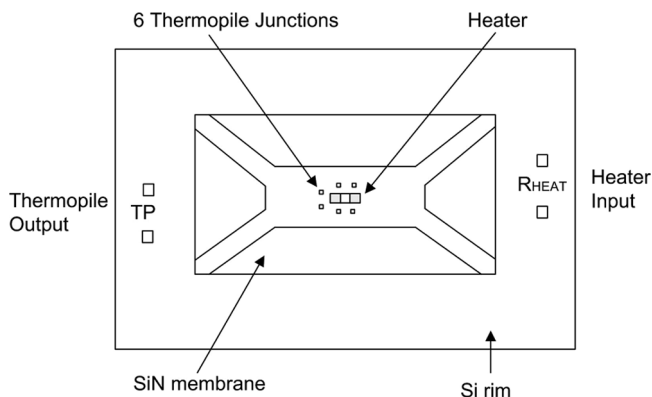

Figure 1. Scheme of the thermal conductivity gauge sensor.

chamber $8\text{ cm} \times 6\text{ cm} \times 3\text{ cm}$. The chamber had an inlet and outlet to allow its use under vacuum, air, or nitrogen. It was sealed with a 9-mm-thick glass window to allow optical monitoring.

The power supply to the heaters (0–5 V) and the recording of the voltage change of the thermopiles were provided by a Semiconductor Parameter Analyzer, model 4145A of Hewlett-Packard (HP). A scheme of the experimental setup is shown in Fig. 2.

Typically, the voltage (0–5 V) was supplied in 1.6 s, resulting in rates up to 3.125 V/s. Roughly, the temperature of the heater is proportional to the square of the applied voltage. The deviations from this relation occur due to changes in the device heat capacity, changes in heat loss rate with temperature, and changes in heater resistivity with temperature (TCR). The voltage supplied to the heater reflects the supplied heat (power) rather than the sample temperature.

The thermopile temperature as a function of the heater voltage is shown in Fig. 3 for two cases: (1) bare (unloaded) heater and (2) heater that is loaded with 50- μm sand grains. The thermogram shows a subparabolic behavior as discussed above. Obviously, the temperature of the loaded device is lower than the empty one. This effect relates to the heat capacity of the sample material.

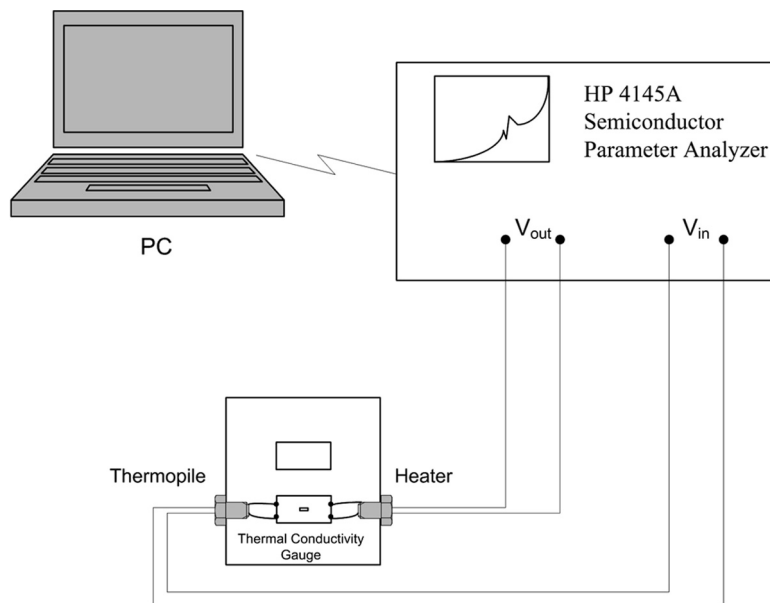

Figure 2. Scheme of the experimental setup (not to scale).

Thus, the abscissas of the thermograms in this article are expressed in terms of heater applied voltage instead of the temperature.

The thermograms that represent temperature differences induced by the sample material were obtained by subtracting the temperature of an empty sensor (reference) from a loaded sensor. No attempt was made in this study to affect a linear change of temperature.

The testing chamber was placed on a Signatone hybrid probe station under an Olympus stereo-microscope model SZ-STB1 equipped with a digital video camera (iSC-2050, i-Sight, Haifa, Israel). The optical monitoring of the samples enabled us to correlate the thermal peaks with visual physical changes such as melting, explosion, movement, etc.

Explosives used in this study were TNT, RDX, picric acid, urea nitrate, and TATP. All the explosives used in our study were in the form of fine powder (grain size in the range of

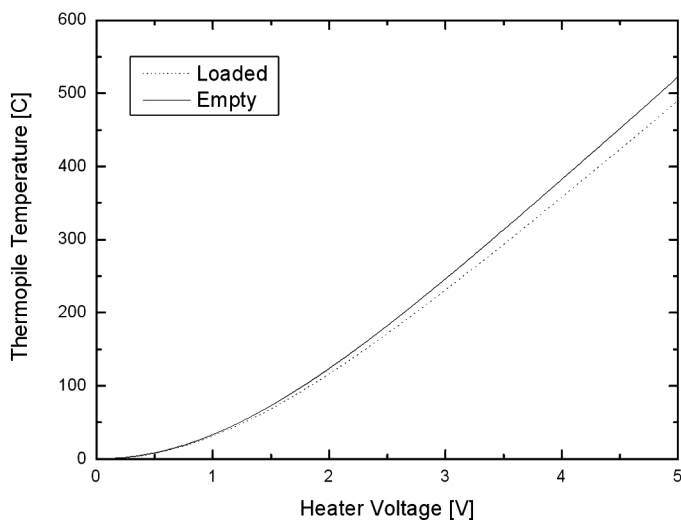

Figure 3. Thermopile temperature against heater applied voltage as obtained in unloaded heater (straight line) and heater loaded with sea sand grain (dotted line).

10–200 μm) or flakes (TNT). Sugars used in our study were trehalose-dihydrate and agarose (both obtained from Sigma-Aldrich, Israel). The sugars were ground to ca. 50- μm particles.

The samples were manually placed on the heater in the center of the thermal conductivity gauge by means of a flexible fiber. The testing chamber was sealed with the glass lid using a silicone rubber gasket and was flushed for 5 min with the desired gas (air or N_2) prior to testing.

Results and Discussion

Some characteristic cases of microthermal analysis of different materials are discussed below. For representatives of innocent materials we chose sea sand, polyethylene, and sugars. Sand, which chemically represents a common dust, is a high melting temperature inorganic material. Polyethylene (PE), which is a widely used polymer, is an organic material that contains hydrogen and carbon but not oxygen. PE has a melting point

of about 133.5°C [7]. Sugars are organic compounds that have high oxygen content and therefore are potentially combustible. Two sugars were tested: trehalose (dihydrate) and agarose, which have distinct melting points (98 and 260°C , respectively). The explosive materials that we used were both standard (TNT, RDX, and picric acid) and improvised explosives (urea nitrate and TATP). TNT (2,4,6-trinitrotoluene) is the most widely used military explosive. Its main features include low melting point, stability, low sensitivity to impact, and relative safe methods of manufacture [1]. RDX (1,3,5-trinitro-1,3,5-triazacyclohexane) is one of the most important military explosives used today. Its explosive power is greater than that of TNT; however, it is more susceptible than TNT to shock and thermal detonation [1]. Picric acid is a standard explosive but with limited use. Urea nitrate is a common fertilizer, which can be used as an improvised explosive (e.g., the 1993 terror attack in the underground parking lot of the World Trade Center). TATP (triacetone triperoxide) is a powerful improvised explosive that is commonly used by terrorists due to its simple preparation procedure from readily available precursors. TATP is an unstable compound and has a high vapor pressure [1].

Figure 4 shows the thermogram of a grain of sand in air at a heating rate of $\sim 300^{\circ}\text{C}/\text{s}$. The measured thermogram is a smooth line without a visible endotherm or exotherm. The baseline of the differential temperature dips due to the heat capacity of the sand sample compared to the reference (empty) microcalorimeter. During the heating no visual change of the sample was observed.

Figure 5a shows the thermogram of an iron chip that is also similar to the thermogram of sea sand grain in Fig. 3, and actually for any large, high melting point sample. Figure 5b shows the thermogram of the same iron chip removed by a magnet (at heater applied voltage of 2.25 V). The effect of mass removal is expressed in the thermogram with the fast return of the base line to zero.

Figure 6 shows the thermogram of polyethylene (PE) in air. The baseline dips from the beginning of the measurement due to the heat capacity of the sample. The thermogram shows also

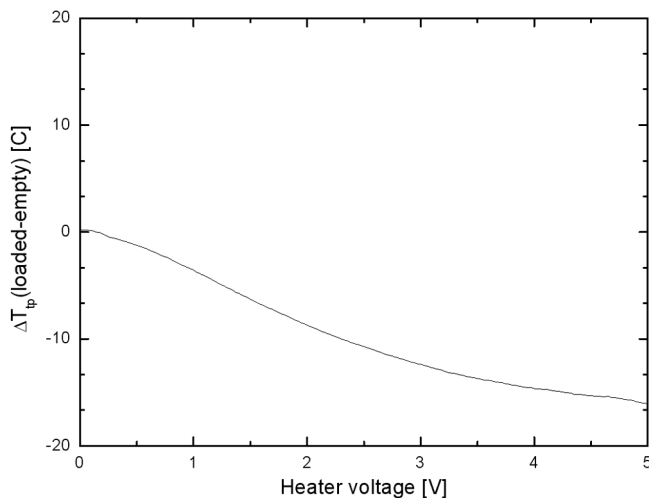

Figure 4. Microcalorimeter thermogram of sea sand grain in air atmosphere ($\sim 300^\circ\text{C}/\text{s}$).

a clear endotherm at an applied voltage of 2.12 V, which represents the melting of the PE sample. The melting was also visually observed. Adamovsky et al. [7] had measured the crystallization of PE by DSC and obtained a melting temperature of 406.5 K (133.5°C).

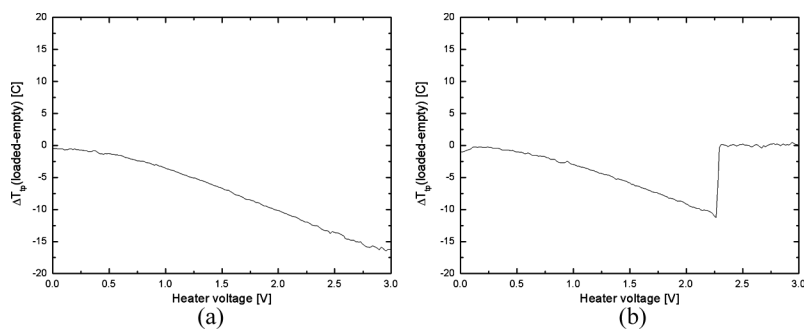

Figure 5. Microcalorimeter thermograms of iron chip (left) and the same iron chip removed by a magnet (right).

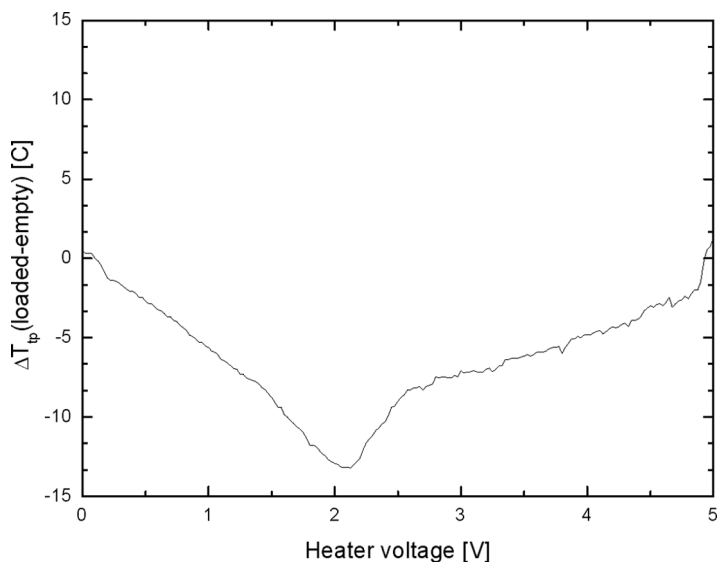

Figure 6. Microcalorimeter thermogram of polyethylene in air atmosphere ($\sim 300^\circ\text{C/s}$).

Figure 7a shows the thermogram of a $50\text{-}\mu\text{m}$ ($\sim 100\text{ ng}$) RDX particle in air. An endothermic peak due to melting is visible at 2.55 V . Immediately after melting, an explosion of the particle was observed, which registered on the thermogram as a sharp exotherm at a heater voltage of about 3 V .

Figure 7b shows the thermogram of urea nitrate in air. A sharp endothermic peak is shown at applied voltage of about 2.1 V . Immediately after that, a low-amplitude exothermic peak is observed at heater voltage of about 2.5 V . Assuming that the sample's mass is similar to the other tested materials shown in Fig. 5, this result may indicate that the explosion power of this improvised explosive is lower compared to standard explosives.

Figure 7c shows the thermogram of TNT in air. For this explosive an endotherm (melting) occurred at applied voltage of 1.4 V and an exotherm (explosion) occurred at 2.1 V . Two more exothermic peaks are visible at applied voltages of 2.6 and 4.6 V . The secondary peaks probably occur due to the large temperature difference between the melting to the initiation

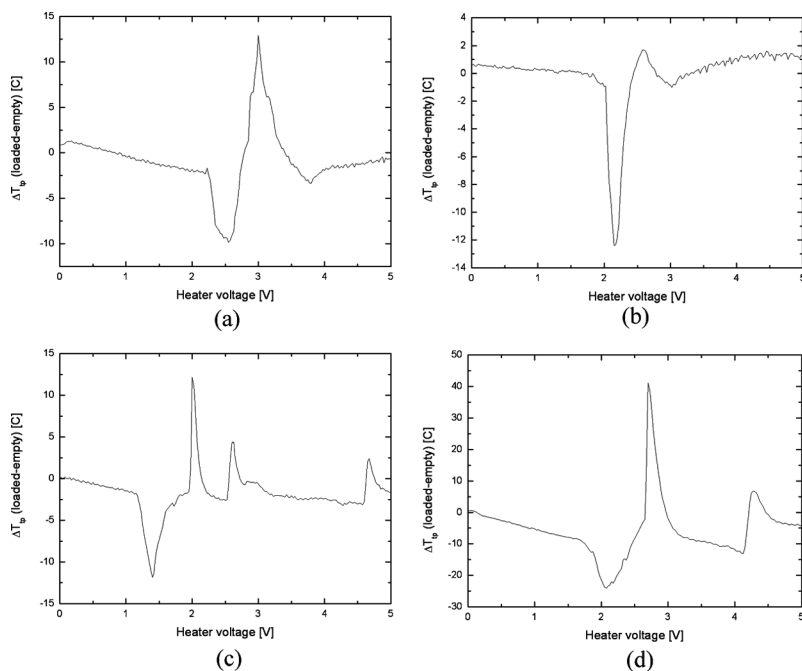

Figure 7. Microcalorimeter thermogram of RDX (a), urea nitrate (b), TNT (c), and picric acid (d) in air atmosphere ($\sim 300^\circ\text{C}/\text{s}$).

temperatures of TNT. The melt had sufficient time to spread on the heater and then to flow to the surrounding membrane. In this situation the material is not concentrated at one point but is rather spread over a large area. The heat supplied by the heater propagates laterally from the heater in the center to the surrounding membrane, and the material at the far end can reach the initiation temperature with some delay from the first explosion. Higher heating rates, and probably a well-shaped heater, may solve the problem. Indeed, preliminary results at higher heating rates ($500^\circ\text{C}/\text{min}$) have proved that only one exothermic peak has appeared.

Figure 7d shows the thermogram of picric acid under the same conditions. An endothermic peak at 2.1 V followed by a

sharp exothermic peak at 2.8 V was recorded. Similarly to TNT, the exothermic peak appears together with some secondary exothermic peaks (e.g., at 4.6 V). This similarity makes sense due to relatively large difference between the melting and initiation temperatures of picric acid, as reflected from its thermogram, and due to the chemical and physical similarity to TNT.

Figure 8a shows a thermogram of a 50- μm TATP sample. At applied voltage of about 1.5 V a sharp endothermic peak was recorded; however, no explosive characteristic exothermic peak can be seen. The absence of an exothermic peak for TATP is surprising considering the fact that this is a very sensitive explosive. A possible explanation might be that this happened due to complete evaporation of the TATP before reaching the initiation temperature. It is therefore necessary to reach the initiation temperature by heating TATP at higher rate than its evaporation rate. Due to limitation of our experimental setup we could not work at higher heating rate. We then repeated the measurement with a larger TATP grain. The result is shown in Fig. 8b. Here the endothermic peak appears at a voltage of 2.2 V and an exotherm is visible at 2.6 V. However, note that the baseline dips strongly and the melting endotherm shifts toward higher voltages due to the large heat capacity of the sample.

Figure 9a shows the thermogram of trehalose dihydrate in air, which has a melting point of 98°C. A spiky endotherm that

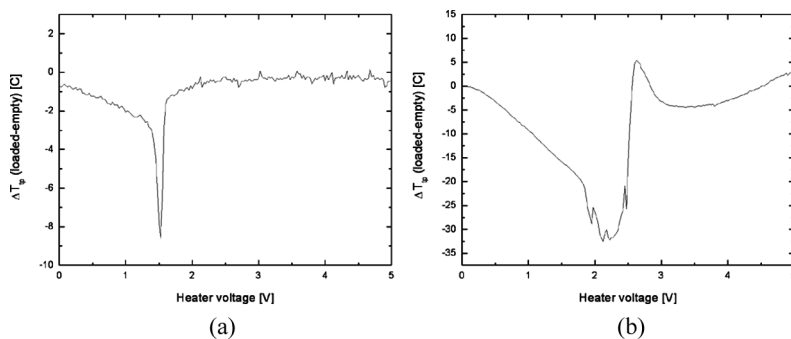

Figure 8. Microcalorimeter thermogram of small (a) and large (b) grain of TATP in air atmosphere ($\sim 300^\circ\text{C}/\text{s}$).

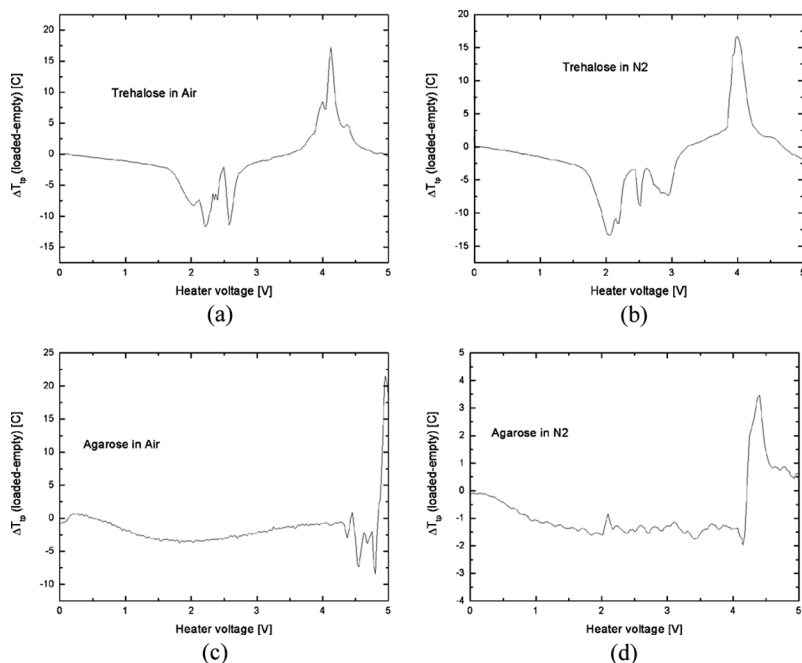

Figure 9. Microcalorimeter thermogram of trehalose in air (a) and under N₂ atmosphere (b); agarose in air (c) and under N₂ atmosphere (d) ($\sim 300^\circ\text{C/s}$).

represents the melting event is observed at a heating voltage in the range of 1.8–3 V. A sharp exothermic peak is also present at a voltage of about 4 V. By visually monitoring the measurement, we observed a long melting process associated with the endotherm and a sudden release of a vapor cloud associated with the exotherm peak. The spiky endotherm is attributed to the fact that the complete melting process, under the conditions of the measurement, is relatively slow due to either polycrystallinity, low thermal conductivity of the sample, and/or poor thermal contact between the trehalose sample and the microcalorimeter. Indeed, slower heating rate allows obtaining of sharp endotherm rather than the wide and spiky endotherm that is shown here. No doubt that the appearance of an

exothermic peak for sugars is surprising at first glance since stable compounds are expected to decompose endothermally [4]. Since the measurement was carried out in air it can be argued that the presence of oxygen may result in ignition of the organic material at elevated temperatures. This process is exothermic. Similar measurements were therefore conducted under N_2 atmosphere. The thermogram of trehalose under N_2 , as shown in Fig. 9b, reveals, however, a similar pattern: a wide and spiky endotherm that is related to the melting, at about 2–3 V, and an exothermic peak at about 4 V. The measurements in these conditions were repeated several times and similar thermograms were obtained, even when the chamber was flushed with nitrogen several times to ensure the removal of oxygen residues from the chamber.

It is noted that the measurements performed by Chen et al. were limited to heating up to 300°C , while the measurements in this study may reach 530°C as shown in Fig. 3. The peak at applied voltage of 4 V approximately equals a temperature of 370°C .

It is therefore argued that the exothermic peaks that appear in the thermograms are due to internal presence of oxygen in the system. The origin of the oxygen can be the two water molecules that are part of the crystal, oxygen or water adsorbed in the pores, or due to the molecular oxygen content of the sugar. Similar thermograms were recorded when trapped gases from the sample were removed by preheating the trehalose sample under N_2 to the melting point, cooling it, and then repeating the same experiment while keeping the chamber under N_2 . The exotherms are apparently due to the molecular oxygen content of the sugar.

Figure 9c shows the thermogram of agarose under air atmosphere. A spiky endotherm, which represents the melting event, is observed at heater voltages between 4.3 and 4.8 V. A sharp exothermic peak is shown at about 5 V. Similarly to trehalose dihydrate, visual monitoring of the measurement correlated between the physical changes in the sample (melting and a sudden releasing of vapor cloud) and the measured thermogram. The thermogram of agarose under N_2

atmosphere, as shown in Fig. 9d, reveals a similar pattern: an endotherm that represents the melting event is observed at 4.1 V. The apparently high melting point temperature can be related to different reasons such as low thermal conductivity of the sample, poor thermal coupling of the sample to the heater, etc. A sharp exothermic peak is shown at 4.1 V. A practical conclusion from the last thermograms is that some innocent materials may show an exothermic peak when they are heated to sufficiently high temperatures. It should be noted that the results for all tested materials are not affected by the presence of air.

The results shown above demonstrate the fundamental suitability of the microcalorimeter to be used for explosive identification by microthermal analysis. The distinguishing between explosives and innocent materials is based upon obtaining characteristic exotherms for explosive materials at moderate temperature ($\sim 250^\circ\text{C}$) even when working in oxygen-containing atmospheres. The nonexplosive materials are characterized by endothermic peaks only or no peak at all at the moderate temperature range, but exothermic peak may appear at elevated temperatures ($\sim 400^\circ\text{C}$). The difference in melting point can be a criterion for material identification; however, since the melting point is dependent on the size of the particle, other criteria such as difference in locations between the endotherms and exotherms might be applied. In addition to the exotherms, all tested explosives exhibited a melting endotherm before the detonation exotherm. For practical reasons, the ability to work under air atmosphere as demonstrated in this study is an advantage and a preferred option. This can be done by performing the measurement under 300°C , a temperature range that all the examined explosives have shown exotherms. In the thermogram of RDX (Fig. 7a) the signal-to-noise ratio was ~ 30 . By assuming that the sensor response is linear with the particle mass the minimum detectable level is estimated to be in the low nanogram range. Improving the electronic circuitry used for measuring the microcalorimeter temperature as well as understanding the relationship between the particle mass and the sensor response is ongoing.

Practically, the microcalorimeter should be coupled to a particle collecting and classifying unit that will control the size and mass of the analyzed particles and will direct the particle to the desired location on the heater.

More quantitative results will be shown in the near future when upgrading of the measurement system will be completed.

Conclusions

A feasibility study of explosive detection analyzer based on microthermal analysis was carried out. A thermal conductivity gauge was used as microcalorimeter. The measurements were performed in air and under N_2 atmosphere. Different materials were studied: standard and improvised explosives (TNT, RDX, picric acid, urea nitrate, and TATP) as well nonexplosive compounds (sea sand, polyethylene, trehalose, and agarose). Clear, well-resolved exotherms were obtained for all types of explosive materials when heating to moderate temperature ($\sim 250^\circ C$). In addition to this exotherms, all explosives exhibited a melting endotherm prior to the exotherm. Sea sand showed no peaks at the heating temperature range, which is up to $520^\circ C$. Polyethylene showed an endotherm representing its melting. The sugars showed an endotherm but also show an exotherm when heated to elevated temperature ($> 370^\circ C$). These exotherms appear under both air and N_2 atmosphere. The thermogram of each material depends on its physical and chemical properties and is characterized with a unique pattern. This pattern might enable the detection and identification of explosive particles. It is suggested that microcalorimetry can be used for the development of a field-portable explosive detector.

While the characterization of explosive particles by microthermal analysis looks possible, a great challenge is by bringing the particle from the external world to the sensor. The microcalorimeter device should therefore be coupled to a particle sampling unit that will collect and guide the particles to the microcalorimeter. The development of this unit is ongoing.

Assuming that each micrometric size particle is made of pure material, the sampling process will yield particles of not only explosives but also interfering, or masking, materials such as inorganic and organic dust. By measuring each particle separately, using an array of microcalorimeters, the nature of each particle will be determined. The detection of even one explosive particle will be alerted by the system as an indication for the presence of explosive.

By meeting the real-world requirements of low cost and minimal use of consumables, the system should allow multiply measurements ability. For this purpose, a cleaning and refreshment procedure for the microcalorimeter array should be developed. This study is also ongoing.

References

- [1] Yinon, J. 1999. *Forensic and Environmental Detection of Explosives*. Chichester, UK: John Wiley & Sons.
- [2] Theisen, L., D. W. Hannum, D. W. Murray, and J. E. Parmeter. 2004. *Survey of Commercially Available Explosives Detection Technologies and Equipment*. Document No. 208861. Office of Science and Technology, U.S. Department of Justice. <http://www.ncjrs.gov/pdffiles1/nij/grants/208861.pdf>
- [3] www.scent-tech.com/Admin/FileServer/f0f68bf1a82f2c9665131-4763dee3717.pdf
- [4] Chen, C.-C., W. W. Bannister, and A. Viswanathan. 1999. Micro-thermal analysis for airport detection of energetic materials. Proceedings of the 27th Annual Conference of the North American Thermal Analysis Society, pp. 67–72, September 20–22, Savannah, GA.
- [5] Banister, W. W., C. C. Chen, W. A. Curby, E. B. Chen, P. L. Damour, and A. Morales. 2004. Thermal analysis for detection and identification of explosives and other controlled substances. U.S. Patent 6773674 B2.
- [6] Olson, E. A., M. Yu. Efremov, M. Zhang, S. L. Lai, Z. S. Zhang, and L. H. Allen. 2003. The design and operation of a MEMS differential scanning nanocalorimeter for high-speed capacity measurements of ultra thin films. *Journal of Microelectromechanical Systems*, 12: 355–364.

- [7] Adamovsky, S. A., A. A. Minakov, and C. Schick. 2003. Scanning microcalorimetry at high cooling rate. *Thermochimica Acta*, 403: 55–63.
- [8] Adamovsky, S. and C. Schick. 2004. Ultra-fast isothermal calorimetry using thin film sensors. *Thermochimica Acta*, 415: 1–7.
- [9] www.xensor.com